

**TECHNICKÝ A ZKUŠEBNÍ ÚSTAV
STAVEBNÍ PRAHA, s.p.**

Prosecká 811/76a
CZ-190 00 Praha 9
Tel.: +420 286 019 458
Internet: www.tzus.cz

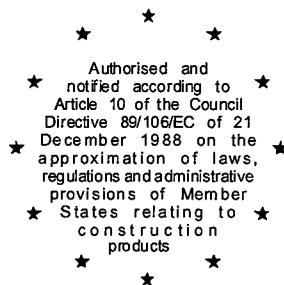

MEMBER OF EOTA

European Technical Approval

ETA-13/0325

(English language translation, the original version is in Czech language)

Obchodní název
Trade name

ECO-FIRST POLYVALENT

Držitel schválení
Holder of approval

SCELL-IT
329, rue de l'industrie
59113 Seclin
France

Typ a použití výrobku
*Generic type and use
of construction product*

Injektážní systém o velikosti M8, M10, M12 a M16 pro
kotvení ve zdivu
*Injection system with sizes M8, M10, M12 and M16 for use in
masonry*

Platnost
Validity
od
from
do
to

26.06.2013
14.10.2017

Výrobna
Manufacturing plant

SCELL-IT Plant 1
Germany

Toto evropské technické schválení
obsahuje
*This European technical approval
contains*

18 stran včetně 11 příloh
18 pages including 11 annexes



European Organisation for Technical Approvals
Evropská organizace pro technické schvalování

I. LEGAL BASES AND GENERAL CONDITIONS

1. This European Technical Approval is issued by the Technical and Test Institute for Construction Prague (Technický a zkušební ústav stavební Praha, s.p.) in accordance with:
 - Council Directive 89/106/EEC of 21 December 1988 on the approximation of laws, regulations and administrative provisions of Member States relating to construction products¹, modified by the Council Directive 93/68/EEC²; and Regulation (EC) No.1882/2003 of the European Parliament and of the Council³
 - the Government Decree No. 190/2002 Collection of Laws⁴, as amended
 - Common Procedural Rules for Requesting, Preparing and the Granting of European Technical Approvals set out in the Annex to Commission Decision 94/23/EC⁵;
 - Guideline for European Technical Approval of „Metal Injection Anchors for use in Masonry“, ETAG 029.
2. Technický a zkušební ústav stavební Praha, s.p. is authorised to check whether the provisions of this European Technical Approval are met. Checking may take place in the manufacturing plant. Nevertheless, the responsibility for the conformity of the products to the European Technical Approval and for their fitness for the intended use remains with the holder of the European Technical Approval.
3. This European Technical Approval is not to be transferred to manufacturers or agents of manufacturers other than those indicated on page 1, or manufacturing plants other than those indicated on page 1 of this European Technical Approval.
4. This European Technical Approval may be withdrawn by the Technical and Test Institute for Construction Prague in particular pursuant to information by the Commission according to Article 5.1 of the Council Directive 89/106/EEC.
5. Reproduction of this European Technical Approval including transmission by electronic means shall be in full. However, partial reproduction can be made with the written consent of the Technical and Test Institute for Construction Prague. In this case, partial reproduction has to be designated as such. Texts and drawings of advertising brochures shall not contradict or misuse the European Technical Approval.
6. The European Technical Approval is issued by the approval body in its official language. This version corresponds to the version circulated within EOTA. Translations into other languages have to be designated as such.

¹ Official Journal of the European Communities N° L 40, 11.02.1989, p. 12

² Official Journal of the European Communities N° L 220, 30.08.1993, p. 1

³ Official Journal of the European Union no. L 284, 31.10.2003, p. 1

⁴ Collection of Law of the Czech Republic Vol.79 No190 , 21.5.2002

⁵ Official Journal of the European Communities N° L 17, 20.01.1994, p. 34

II. SPECIFIC CONDITIONS OF THE EUROPEAN TECHNICAL APPROVAL

1 Definition of product and intended use

1.1 Definition of product

The ECO-FIRST POLYVALENT polyester resin styrene-free for masonry is bonded anchor consisting of cartridge with injection mortar, a steel element and a plastic sieve sleeve. The steel elements are the commercial threaded rods in the sizes M8 to M16 with hexagon nut and washer. The steel elements are made of galvanized steel or stainless steel.

The anchor can be installed in solid and hollow masonry.

The installation of the anchor with the sizes M8 and M10 in solid masonry can be done with or without sieve sleeve. The installation of the anchor with the sizes M12 and M16 in solid masonry is done without sieve sleeve.

The sieve sleeve is pushed into a drilled hole and filled with injection mortar. Then the threaded rod is placed in the sieve sleeve. The steel element is anchored via the bond between metal part, injection mortar and masonry.

The installed anchor is shown in Annex 1.

1.2 Intended use

The anchor is intended to be used for anchorages for which requirements for mechanical resistance and stability and safety in use in sense of the Essential Requirements 1 and 4 of Council Directive 89/106/EEC shall be fulfilled and failure of anchorages made with these products would compromise the stability of the works, cause risk to human life and/or lead to considerable economic consequence.

The anchor is to be used only for anchorages subject to static or quasistatic loading in solid masonry (use category b) or hollow or perforated masonry (use category c) according Annex 7. The mortar strength class of the masonry has to be M 2,5 with a strength $\leq 5 \text{ N/mm}^2$ at minimum.

The anchor may be installed and use in dry or wet structures (category w/w).

The anchor may be used in the following temperature ranges:

-40°C to +40°C (max long term temperature +24°C,
max short term temperature +40°C)

Elements made of galvanized steel:

The element made of galvanized steel may only be used in structures subject to dry internal conditions.

Elements made of stainless steel:

The element made of stainless steel may be used in structures subject to dry internal conditions and also in structures subject to external atmospheric exposure (including industrial and marine environmental), or exposure to permanently damp internal conditions, if no particular aggressive conditions exist. Such particular aggressive conditions are e.g. permanent, alternating immersion in seawater or the splash zone of seawater, chloride atmosphere of indoor swimming pools or atmosphere with extreme chemical pollution (e.g. in desulphurization plants or road tunnels where deicing materials are used).

The provisions made in this European Technical Approval are based on an assumed working life of the anchor of 50 years. The indications given on the working life cannot be interpreted as a guarantee given by the producer, but are to be regarded only as a means for choosing the products in relation to the expected economically reasonable working life of the works.

2 Characteristics of the product and methods of verification

2.1 Characteristics of the product

The anchors correspond to the drawings and information given in Annexes. The characteristic material values, dimensions and tolerances of the anchor not indicated in Annexes shall correspond to the respective values laid down in the technical documentation⁶ of this European Technical Approval.

The characteristic values of ECO-FIRST POLYVALENT for the design of the anchorages are given in Annex 9.

The anchor is assumed to satisfy the requirements for class A1 of the characteristic reaction to fire. Regarding resistance to fire no performance is determined.

2.2 Methods of verification

The assessment of the fitness of the anchor for the intended use in relation to the requirements for safety in use in the sense of Essential Requirement 1 and 4 has been made in compliance with the Guideline for European Technical Approval of "Metal Injection Anchors for use in Masonry", ETAG 029, based on the Use Categories b and c in respect of the base material and Category w/w in respect of installation and use.

In addition to the specific clauses relating to dangerous substances contained in this European Technical Approval, there may be other requirements applicable to the products falling within its scope (e.g. transposed European legislation and national laws, regulations and administrative provisions). In order to meet the provisions of the Construction Products Directive, these requirements need also to be complied with, when and where they apply.

3 Evaluation of conformity of the product and CE marking

3.1 System of attestation of conformity

The system of attestation of conformity is the system 1 described in Council Directive 89/106/EEC Annex III, 2 (i), as follows:

Certification of conformity of the product by a notified body based on:

- (a) Tasks of the manufacturer:
 - (1) factory production control,
 - (2) testing of samples taken at the factory by the manufacturer in accordance with a prescribed control plan.
- (b) Tasks of the notified body:
 - (3) initial type-testing of the product,
 - (4) initial inspection of factory and of factory production control,
 - (5) continuous surveillance, assessment and approval of factory production control.

3.2 Responsibility

3.2.1 Tasks of the manufacturer

3.2.1.1 Factory production control

The manufacturer shall exercise permanent internal control of production. All the elements, requirements and provisions adopted by the manufacturer shall be documented in a systematic manner in the form of written policies and procedures, including records of results performed. This production control system shall insure that the product is in conformity with this European Technical Approval.

The manufacturer may only use raw materials stated in the technical documentation of this European Technical Approval.

⁶ The technical documentation of this European Technical Approval is deposited at the Technický a zkušební ústav stavební Praha, s.p., as far as relevant for the tasks of the approved bodies involved in the attestation of conformity producer, is handed over to the approved bodies.

The factory production control shall be in accordance with the control plan which is a part of the technical documentation of this European Technical Approval. The control plan is laid down in the context of the factory production control system operated by the manufacturer and deposited at Technický a zkušební ústav stavební Praha, s.p.⁷.

The results of factory production control shall be recorded and evaluated in accordance with the provisions of the control plan.

3.2.1.2 Other tasks of manufacturer

The manufacturer shall, on the basis of a contract, involve a body which is notified for the tasks referred to in section 3.1 in the field of anchors in order to undertake the actions laid down in section 3.2.2. For this purpose, the control plan referred to in sections 3.2.1.1 and 3.2.2 shall be handed over by the manufacturer to the notified body involved.

The manufacturer shall make a declaration of conformity, stating that the construction product is in conformity with the provisions of this European Technical Approval.

3.2.2 Tasks of the notified body

The notified body shall perform the:

- initial type-testing of the product
- initial inspection of factory and of factory production control
- continuous surveillance, assessment and approval of factory production control

in accordance with the provisions laid down in the control plan.

The notified body shall retain the essential points of its actions referred to above and state the results obtained and conclusions drawn in a written report.

The notified certification body involved by the manufacturer shall issue an EC certificate of conformity of the product stating the conformity with the provisions of this European Technical Approval.

In cases where the provisions of the European Technical Approval and its control plan are no longer fulfilled the certification body shall withdraw the certificate of conformity and inform Technický a zkušební ústav stavební Praha, s.p. without delay.

3.3 CE marking

The CE-marking⁸ shall be affixed on each packaging of the anchor. The symbol "CE" shall be accompanied by the following information:

- the name and address of the producer (legal entity responsible for the manufacture);
- the last two digits of year in which CE marking was affixed;
- the number of the EC certificate of conformity for the product;
- the number of the European Technical Approval;
- ETAG 029;
- size of the anchor;
- use category (b, c and w/w)

⁷ The control plan is a confidential part of the documentation of the European Technical Approval, but not published together with the ETA and only handed over to the approved body involved in the procedure of attestation of conformity. See section 3.2.2.

⁸ Notes on the CE marking are stated in Guidance Paper D „CE marking under the Construction Products Directive“, Brussels, 01 August 2002

4 Assumptions under which the fitness of the product for the intended use was favourably assessed

4.1 Manufacturing

The anchor is manufactured in accordance with the provisions of the European Technical Approval using the automated manufacturing process as verified by the inspection of the plant performed by the Technický a zkušební ústav stavební Praha, s.p. as laid down in the technical documentation.

4.2 Installation

4.2.1 Design of anchorages

The fitness of the anchors for the intended use is given under the following conditions:

The anchorages are designed in accordance with the ETA 029, Annex C Design method A under the responsibility of an engineer experienced in anchorages and masonry work.

Verifiable calculation notes and drawings are prepared taking account the relevant masonry in the region of the anchorage (nature and strength of the base materials), the loads to be transmitted and their transmission to the supports of the structure. The position of the anchor is indicated on the design drawings (e.g. position of the anchor relative to support, etc.).

The characteristic resistances are only valid for kind of bricks according to Annex 7. The characteristic resistances for use in solid masonry are also valid for larger brick sizes and larger compressive strength of the masonry unit.

For other bricks in solid masonry and in hollow or perforated masonry, the characteristic resistance of the anchor may be determined by job site tests according to ETAG 029, Annex B under consideration of the β -factor according to Annex 10, Table 10.

4.2.2 Installation of anchor

The fitness for use of the anchor can only be assumed if the following conditions of installation are met:

- anchor installation carried out by appropriately qualified personnel under the supervision of the person responsible for technical matters on site;
- use of the anchor only as supplied by the manufacturer without exchanging any components of the anchor; commercial standard threaded rods, washers and hexagon nuts may be used if the following requirements are fulfilled:
 - Material, dimensions and mechanical properties according Annex 3
 - Confirmation of material and mechanical properties by inspection certificate 3.1 according to EN 10204:2004,
 - Marking of threaded rod with the envisage embedment depth. This may be done by the manufacturer of the rod or the person on job site
- anchor installation in accordance with the manufacturer's specifications and drawings using the tools indicated in this European Technical Approval;
- checks before placing the anchor to ensure that the use category applies and that the characteristic values of the base material in which the anchor is to be placed, is identical with the values, which the characteristic loads apply for;
- keeping the effective anchorage depth;
- edge distance and spacing not less than the specified values without minus tolerance;
- in case of aborted drill hole, the drill hole shall be filled with mortar;
- keeping the installation parameters (Annex 4);

- hole cleaning and anchor installation in accordance with manufacturer's installation instructions (Annexes 5 and 6)
- marking and keeping the effective anchorage depth;
- during curing of the injection mortar the temperature of the masonry must not fall below -5°C ;
- observing the curing time according to Annex 6, Table 5 until the anchor may be loaded;
- application of the torque moment given in Annex 4 table 3 or 4 using calibrated torque wrench.

4.2.3 Responsibility of the manufacturer

It is in the responsibility of the manufacturer to ensure that the information on the specific conditions according to (1) and (2) including Annexes referred to 4.2.1, 4.2.2 is given to those who are concerned. This information may be made by reproduction of the respective parts of the European Technical Approval. In addition, all installation data shall be shown clearly on the packaging and/or on an enclosed instruction sheet, preferably using illustration(s).

The minimum data required for manual are:

- installation parameters according to Annex 4,
- material and property class of metal parts according to Annex 3, Table 1,
- information on the installation procedure, including cleaning of the hole with the cleaning equipments, preferably by means of an illustration,
- exact volume of injection mortar depend on the relevant installation,
- storage temperature of anchor components, minimum and maximum temperature of the base material, processing time (open time) of the mortar and curing time until the anchor may be loaded according to Annex 6,
- identification of the manufacturing batch,

All data shall be presented in a clear and explicit form.

5 Recommendations for the manufacturer

5.1 Recommendations on packaging, transportation and storage

The mortar cartridges shall be protected against sun radiation and shall be stored according to the manufacturer's instructions in dry conditions.

ECO-FIRST POLYVALENT shall be stored at temperatures of at least $+5^{\circ}\text{C}$ to not more than $+25^{\circ}\text{C}$.

Mortar cartridges with expired shelf life must no longer be used.

The original Czech version is signed by

Ing. Jozef Pôbiš
Head of the Approval Body



Installation in hollow brick; threaded rod with sleeve

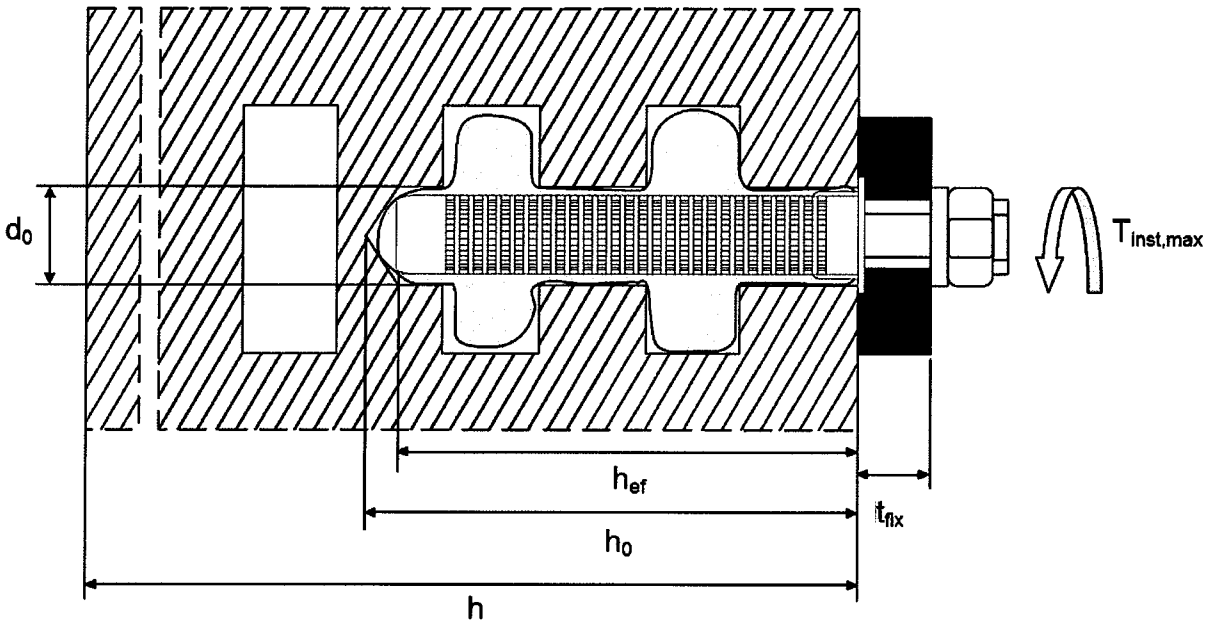

Installation in solid brick; threaded rod with or without sleeve

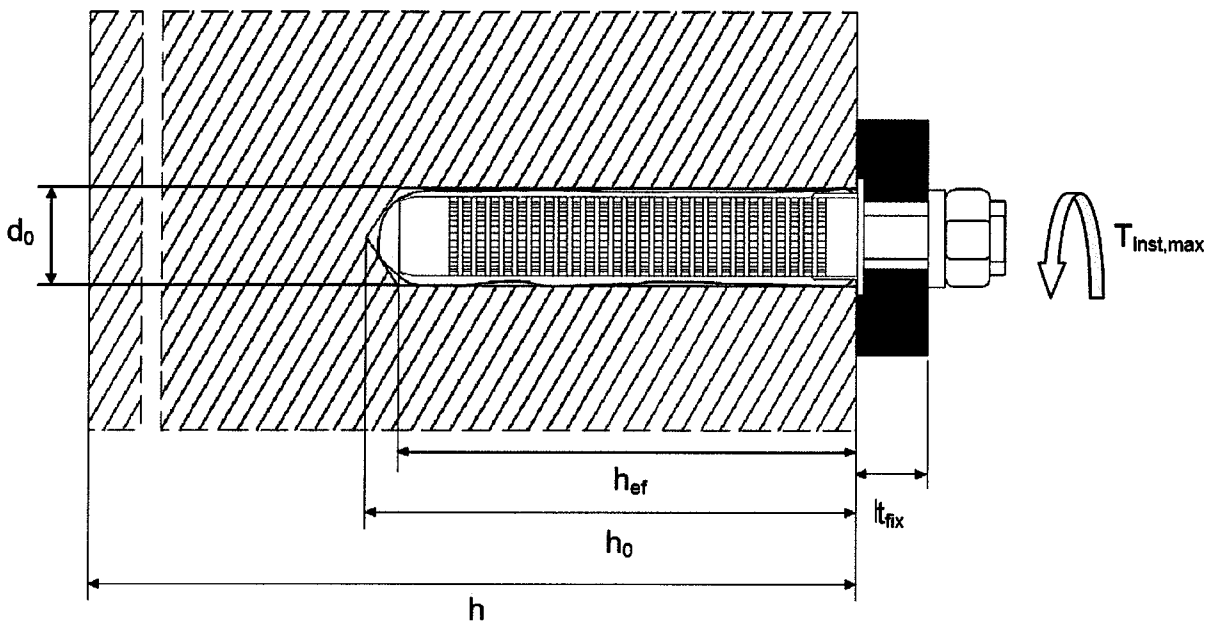

h_{ef} = effective setting depth
 h_0 = bore hole depth
 t_{fix} = thickness of fixture

d_0 = bore hole diameter
 T_{inst} = torque moment

Injection system ECO-FIRST POLYVALENT for masonry

Product and Installation

Annex 1

of European
 Technical Approval
 ETA-13/0325

Cartridge: ECO-FIRST POLYVALENT

150 ml, 280 ml, 300 ml, 330 ml, 380 ml, 410 ml and 420 ml cartridge (Type: coaxial)

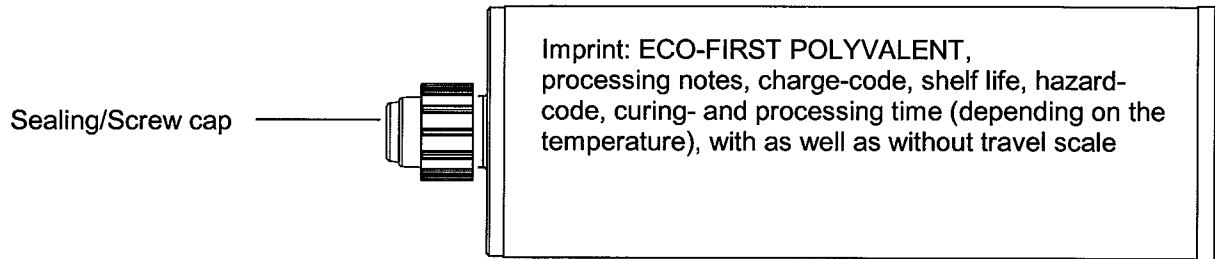

235 ml, 345 ml and 825 ml cartridge (Type: "side-by-side")

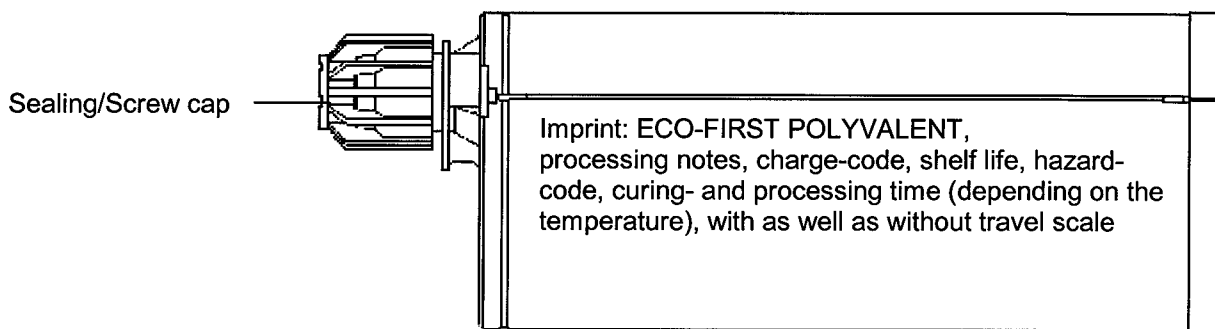

165 ml and 300 ml cartridge (Type: "foil tube")

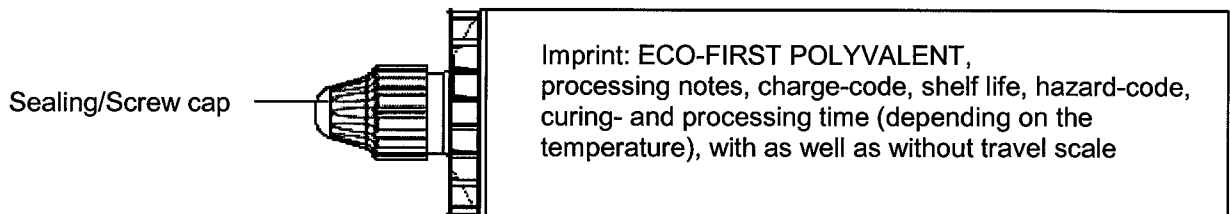

Static mixer

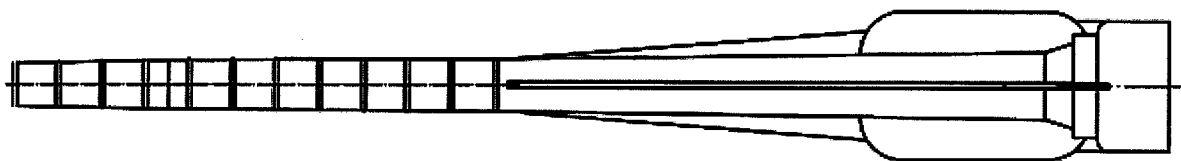

Use category:

Base material: b and c (Solid or hollow masonry)
 Installation and use: w / w (Installation and use in dry, wet masonry)

Temperature range:

-40°C to +40°C (max. short. term temperature +40°C and max. long term temperature +24°C)

Injection system ECO-FIRST POLYVALENT for masonry

Annex 2

of European
 Technical Approval
 ETA-13/0325

Product (injection mortar)

Use category

Threaded rod M8, M10, M12, M16

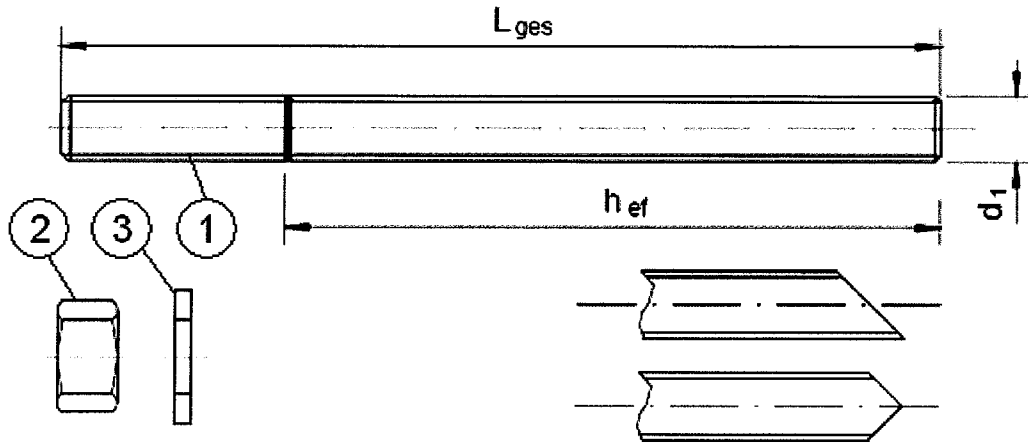

Table 1: Materials

Part	Designation	Material
Steel, zinc plated $\geq 5 \mu\text{m}$ acc. to EN ISO 4042 or Steel, Hot-dip galvanized $\geq 40 \mu\text{m}$ acc. to EN ISO 1461 and EN ISO 10684		
1	Anchor rod	Steel, EN 10087 or EN 10263 Property class 4.8, 5.8, EN ISO 898-1:1999
2	Hexagon nut, EN ISO 4032	EN 20898-2
3	Washer, EN ISO 887, EN ISO 7089, EN ISO 7093 or EN ISO 7094	Steel, zinc plated or hot-dip galvanised
Stainless steel		
1	Anchor rod	Material: A4-70, A4-80, EN ISO 3506
2	Hexagon nut, EN ISO 4032	Material: A4-70, A4-80, EN ISO 3506
3	Washer, EN ISO 887, EN ISO 7089, EN ISO 7093 or EN ISO 7094	Material: A4-70, A4-80, EN ISO 3506

Injection system ECO-FIRST POLYVALENT for masonry

Materials (threaded rod)

Annex 3

of European
 Technical Approval
 ETA-13/0325

Sleeve (Plastic) SH 12x80, SH 16x85, SH 16x130 and SH 20x85

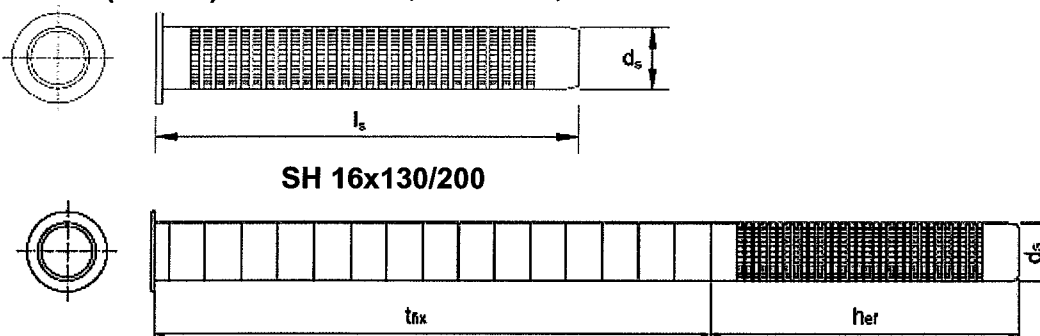

Table 2: Sizes threaded rod and sleeve (mm)

Threaded rods					Sleeves		
Size	d_1	h_{ef}	L_{min}	L_{max}	Size	d_s	l_s
						[mm]	[mm]
M8	8	80	100	500	SH12x80	12	80
M10	10	90	110	500	SH16x85	16	85
					SH16x130	16	130
					SH16x130/200	16	330
M12	12	100	110	500	SH20x85	20	85
M16	16	100	110	500	SH20x85	20	85

Steel brush

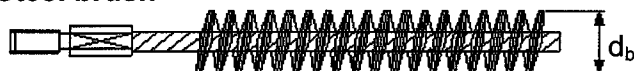

Table 3: Installation parameters in solid masonry (without sleeve)

Threaded rod			M8	M10	M12	M16
Nominal drill hole diameter	d_0	[mm]	10	12	14	18
Embedment depth	h_{ef}	[mm]	80	90	100	100
Bore hole depth	h_0	[mm]	80	90	100	100
Diameter of clearance hole in the fixture	$d_f \leq$	[mm]	9	11	13	17
Diameter of nylon brush	$d_b \geq$	[mm]	11	14	16	18
Torque moment	T_{inst}	[Nm]	2			

Table 4: Installation parameters M8, M10 in solid masonry (with sleeve)

M8, M10, M12, M16 in hollow masonry (with sleeve)

Threaded rod			M8	M10			M12	M16
Sleeve			SH12x80	SH16x85	SH16x130	SH16x130/200	SH20x85	SH20x85
Nominal drill hole diameter	d_0	[mm]	12	16	16	16	20	20
Embedment depth sleeve	h_{nom}	[mm]	80	85	130	130	85	85
Embedment depth rod	h_{ef}	[mm]	80	85	130	130	85	85
Bore hole depth	h_0	[mm]	85	90	135	$135+t_{fix}^1$	90	90
Diameter of clearance hole in the fixture	$d_f \leq$	[mm]	9	11	11	11	13	17
Diameter of nylon brush	$d_b \geq$	[mm]	14	18	18	18	22	22
Torque moment	T_{inst}	[Nm]	2					

¹⁾ $t_{fix} < 200$ mm

Injection system ECO-FIRST POLYVALENT for masonry

Sleeve
 Brush
 Installation parameters

Annex 4

of European
 Technical Approval
 ETA-13/0325

Assembly instructions

Preparation of cartridge

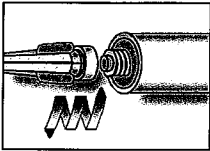

1. Remove the cap and attach the supplied static-mixing nozzle to the cartridge and load the cartridge into the correct dispensing tool. Cut off the foil tube clip before use. For every working interruption longer than the recommended working time (Table 4) as well as for new cartridges, a new static-mixer shall be used.

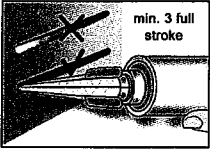

2. Prior to dispensing into the anchor hole, squeeze out separately a minimum of three full strokes and discard non-uniformly mixed adhesive components until the mortar shows a consistent grey colour.

Installation in solid masonry (without sleeve)

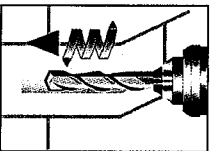

3. Drill a hole into the base material to the size and embedment depth required by the selected anchor (Table 4).

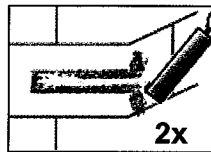
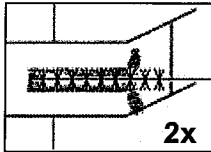
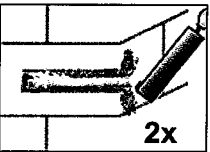

4. Blow from the bottom of the bore hole two times. Brush the hole clean two times, and finally blow out the hole again two times.

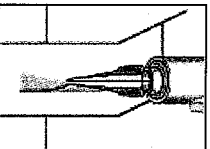

5. Starting from the bottom or back of the cleaned anchor hole fill the hole up to approximately two-thirds with adhesive. Slowly withdraw the static mixing nozzle as the hole fills to avoid creating air pockets. Observe the gel-/ working times given in Table 5.

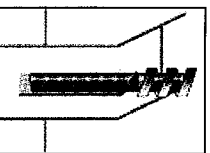

6. Push the threaded rod into the anchor hole while turning slightly to ensure positive distribution of the adhesive until the embedment depth is reached. The anchor should be free of dirt, grease, oil or other foreign material.

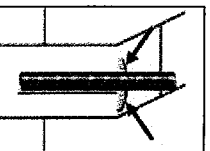

7. Be sure that the anchor is fully seated at the bottom of the hole and that excess mortar is visible at the top of the hole. If these requirements are not maintained, the application has to be renewed.

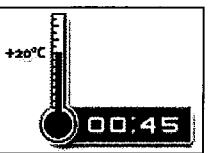

8. Allow the adhesive to cure to the specified time prior to applying any load or torque. Do not move or load the anchor until it is fully cured (attend Table 5).

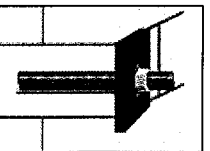

9. After full curing, the add-on part can be installed with the max. torque (Table 4) by using a calibrated torque wrench.

Injection system ECO-FIRST POLYVALENT for masonry

Annex 5

of European
 Technical Approval
 ETA-13/0325

Installation instruction (solid brick)

Assembly Instructions (continuation)

Installation in solid and hollow masonry (with sleeve)

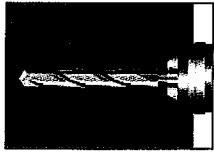

3. Drill a hole into the base material to the size and embedment depth required by the selected anchor (Table 4).

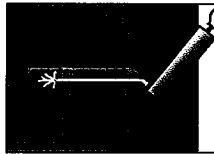
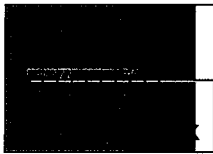
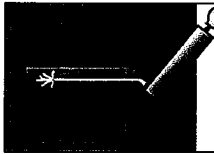

4. Blow from the bottom of the bore hole two times. Brush the hole clean two times, and finally blow out the hole again two times.

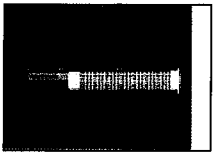

5. Insert the sleeve into the bore hole.

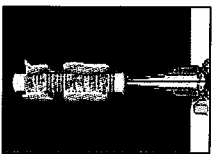

6. Starting from the bottom or back fill the sleeve completely with adhesive. For exact quantity of mortar attend cartridge label. Observe the gel-/ working times given in Table 5.



7. Push the threaded rod into the anchor hole while turning slightly to ensure positive distribution of the adhesive until the embedment depth is reached. The anchor should be free of dirt, grease, oil or other foreign material.

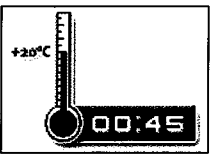

8. Allow the adhesive to cure to the specified time prior to applying any load or torque. Do not move or load the anchor until it is fully cured (attend Table 5).

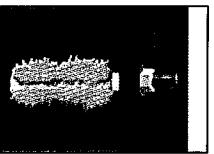

9. After full curing, the add-on part can be installed with the max. torque by using a calibrated torque wrench.

Table 5: Minimum curing time

Base material temperature [°C]	Gelling- / working time [mm]	Minimum curing time [min]
-5 to 0	90	360
0 to +5	45	180
+5 to +10	25	120
+10 to +20	15	80
+20 to +30	6	45
+30 to +35	4	25
+35	2	20

Injection system ECO-FIRST POLYVALENT for masonry

Assembly instructions (hollow brick)
 Gelling and curing time

Annex 6

of European
 Technical Approval
 ETA-13/0325

Types of brick and dimensions

Brick No. 1

Clay masonry
 MZ DF
 acc. to EN 771-1
 $\rho \geq 1,8$ [kg/dm³]
 $f_b \geq 28$ [N/mm²]

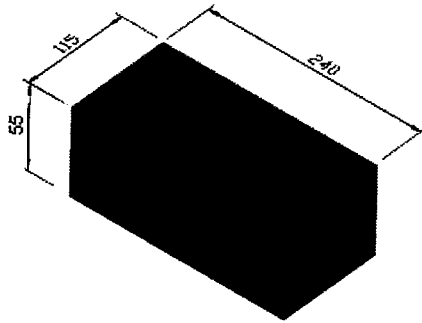

Brick No. 2

Calcium silicate masonry
 KS 20 – 2,0 – NF
 acc. to EN 771-1
 $\rho \geq 2,0$ [kg/dm³]
 $f_b \geq 20$ [N/mm²]

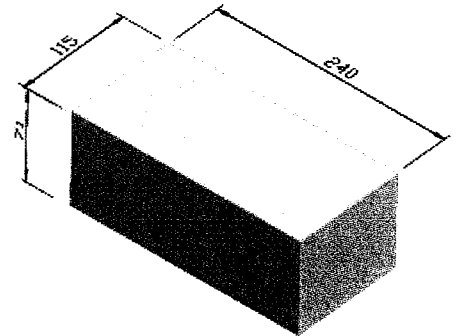

Brick No. 3

Clay masonry
 16 DF
 acc. to EN 771-1
 $\rho \geq 0,9$ [kg/dm³]
 $f_b \geq 12$ [N/mm²]

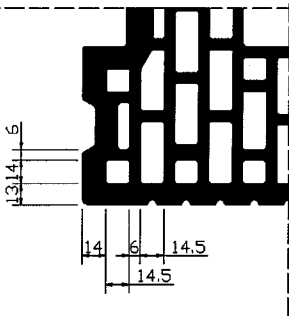
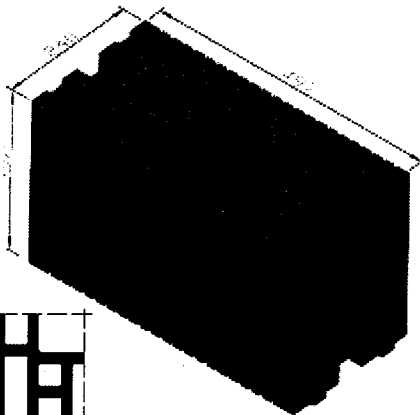

Brick No. 4

Calcium silicate masonry
 KSL 12 -1,4- 3DF
 acc. to EN 771-1
 $\rho \geq 1,4$ [kg/dm³]
 $f_b \geq 12$ [N/mm²]

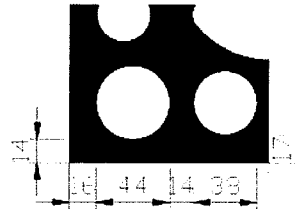
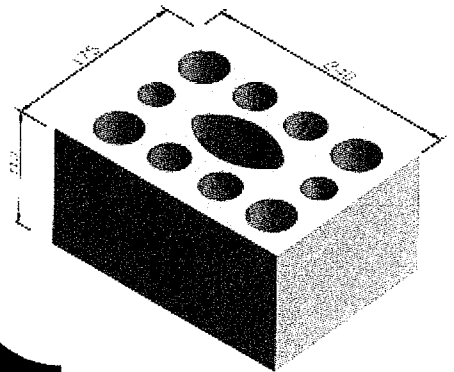

Brick No. 5

Hollow brick
 Bloc creux B40
 acc. to EN 771-3
 $\rho \geq 1,0$ [kg/dm³]
 $f_b \geq 4$ [N/mm²]

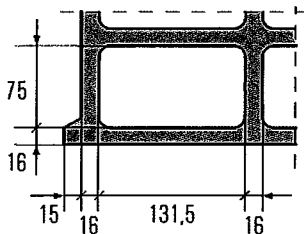
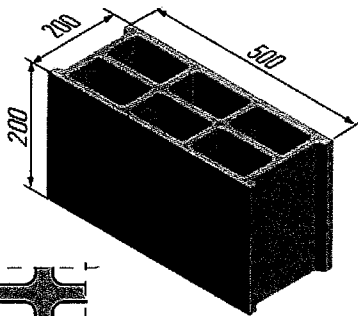

Injection system ECO-FIRST POLYVALENT for masonry

Annex 7

of European
 Technical Approval
 ETA-13/0325

Types of bricks and dimensions

Table 6: Allocation of anchor rods¹⁾, sleeves¹⁾ and bricks

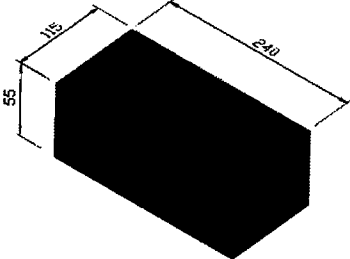
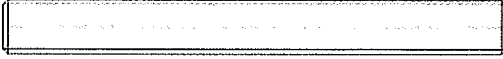
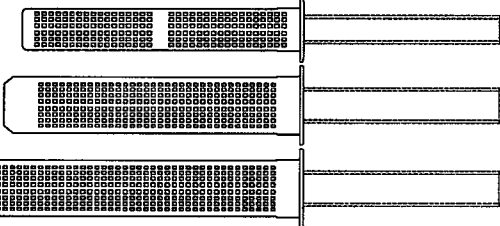
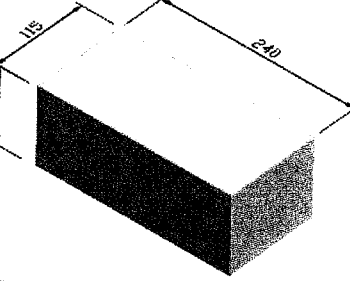
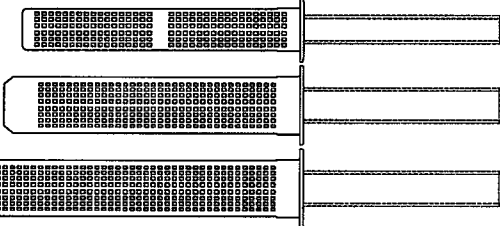
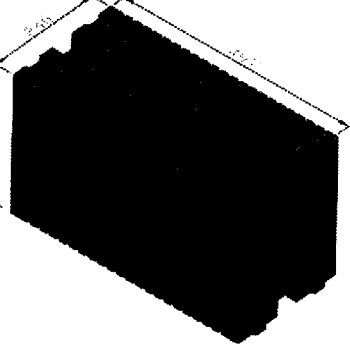
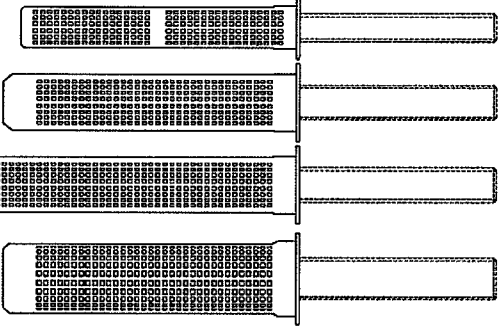
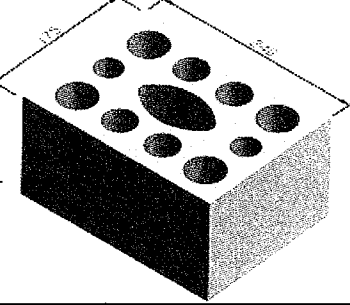
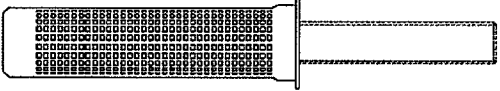
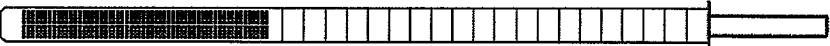
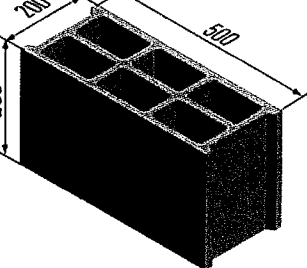
Bricks	Valid anchor rods and sleeves
<p>No 1</p> 	 <p>M8; M10; M12; M16</p>  <p>SH 12x80 SH 16x85 SH 16x130</p>
<p>No 2</p> 	 <p>SH 12x80 SH 16x85 SH 16x130</p>
<p>No 3</p> 	 <p>SH 12x80 SH 16x85 SH 16x130 SH 20x85</p>
<p>No 4</p> 	 <p>SH 16x130 SH 20x85</p>  <p>SH 16x130/220</p>
<p>No 5</p> 	

¹⁾ Other combinations can be used after job site test acc. to ETAG 029, Annex B
 The β -factors for this job site test are given in Table 10

Injection system ECO-FIRST POLYVALENT for masonry

Annex 8

of European
 Technical Approval
 ETA-13/0325

Allocation of anchor rods, sleeve and bricks

Table 7: Characteristic values for tension and shear load

Brick No.		Sleeve	Anchor size	Effective embedment depth h_{ef} [mm]	Characteristic resistance	
					$N_{Rk}^{1)}$ [kN]	$V_{Rk}^{2,3)}$ [kN]
1	Density $\rho \geq 1,8$ [kg/dm ³] Compressive strength $f_b \geq 28$ [N/mm ²]	without	M8	80	3,0	3,0
		without	M10	90	3,0	3,0
		without	M12	100	2,5	2,5
		without	M16	100	4,5	4,5
		SH 12x80	M8	80	3,5	3,5
		SH 16x85	M10	85	3,5	3,5
		SH 16x130	M10	130	5,0	4,0
		SH 16x130/200	M10	130	5,0	4,0
2	Density $\rho \geq 2,0$ [kg/dm ³] Compressive strength $f_b \geq 20$ [N/mm ²]	without	M8	80	6,0	4,0
		without	M10	90	6,0	3,5
		without	M12	100	7,0	5,0
		without	M16	100	6,0	5,0
		SH 12x80	M8	80	5,0	5,0
		SH 16x85	M10	85	5,0	4,0
		SH 16x130	M10	130	5,0	5,0
		SH 16x130/200	M10	130	5,0	5,0
3	Density $\rho \geq 0,9$ [kg/dm ³] Compressive strength $f_b \geq 12$ [N/mm ²]	SH 12x80	M8	80	1,5	1,5
		SH 16x85	M10	85	2,0	2,0
		SH 16x130	M10	130	3,0	2,5
		SH 16x130/200	M10	130	3,0	2,5
		SH 20x85	M12	85	3,5	2,5
		SH 20x85	M16	85	3,5	2,5
4	Density $\rho \geq 1,4$ [kg/dm ³] Compressive strength $f_b \geq 12$ [N/mm ²]	SH 12x80	M8	80	3,5	2,5
		SH 16x85	M10	85	3,0	2,5
		SH 16x130	M10	130	4,5	2,5
		SH 16x130/200	M10	130	4,5	2,5
		SH 20x85	M12	85	3,0	2,5
		SH 20x85	M16	85	3,0	2,5
5	Density $\rho \geq 1,0$ [kg/dm ³] Compressive strength $f_b \geq 4$ [N/mm ²]	SH 12x80	M8	80	0,4	0,4
		SH 16x85	M10	85	0,4	0,4
		SH 16x130	M10	130	2,0	2,0
		SH 16x130/200	M10	130	2,0	2,0
		SH 20x85	M12	85	0,9	0,9
		SH 20x85	M16	85	0,75	0,75
Partial safety factor γ_M					2,5 ⁴⁾	

- 1) For design according to ETAG 029, Annex C: $N_{Rk} = N_{Rk,p} = N_{Rk,b} = N_{Rk,s}$;
 $N_{Rk,pb}$ according to ETAG 029, Annex C
- 2) For design according to ETAG 029, Annex C: $V_{Rk} = V_{Rk,b} = V_{Rk,s}$
- 3) hollow masonry: $V_{Rk,c} = V_{Rk}$; solid masonry: $V_{Rk,c}$ according to ETAG 029, Annex C
- 4) In absence of national regulations

Table 8: Characteristic values bending moments

		M8	M10	M12	M16
Characteristic bending moment, Steel, property class 4.8	$M_{Rk,s}$ [Nm]	15	30	52	133
Partial safety factor	$\gamma_{Ms,V}^{1)}$	1,25			
Characteristic bending moment, Steel, property class 5.8	$M_{Rk,s}$ [Nm]	19	37	66	166
Partial safety factor	$\gamma_{Ms,V}^{1)}$	1,25			
Characteristic bending moment, Stainless steel A4, property class 70	$M_{Rk,s}$ [Nm]	26	52	92	233
Partial safety factor	$\gamma_{Ms,V}^{1)}$	1,56			
Characteristic bending moment, Stainless steel A4, property class 80	$M_{Rk,s}$ [Nm]	30	60	105	266
Partial safety factor	$\gamma_{Ms,V}^{1)}$	1,33			

Injection system ECO-FIRST POLYVALENT for masonry

Characteristic tension load and shear load values
Characteristic values bending moments

Annex 9

of European
Technical Approval
ETA-13/0325

Table 9: Displacement under shear and tension load

Brick No.	Sleeve	Anchor size	Tension		Shear	
			Load	Displacement	Load	Displacement
			F	δ_{NO} $\delta_{N\infty}$	F	δ_{VO} $\delta_{V\infty}$
			[kN]	[mm]	[kN]	[mm]
1	without	M8		0,1 0,2		0,4 0,6
	without	M10		0,1 0,2		0,7 1,1
	without	M12		0,2 0,4		0,4 0,7
	without	M16		0,2 0,3		0,5 0,7
	SH 12x80	M8		0,2 0,3		2,3 3,4
	SH 16x85	M10		0,2 0,3		0,5 0,7
	SH 16x130	M10		0,2 0,3		1,1 1,6
SH 16x130/200	M10		0,2 0,3		1,1 1,6	
2	without	M8		0,2 0,3		1,6 2,4
	without	M10		0,2 0,5		1,5 2,3
	without	M12		0,2 0,3		1,1 1,6
	without	M16		0,2 0,3		1,1 1,6
	SH 12x80	M8		0,2 0,3		3,1 4,6
	SH 16x85	M10		0,2 0,3		1,5 2,2
	SH 16x130	M10		0,2 0,3		1,2 1,8
SH 16x130/200	M10		0,2 0,3		1,2 1,8	
3	SH 12x80	M8	$\frac{N_{Rk}}{1,4 \cdot \gamma_M}$	0,3 0,6	$\frac{V_{Rk}}{1,4 \cdot \gamma_M}$	1,1 1,6
	SH 16x85	M10		0,6 1,1		1,6 2,4
	SH 16x130	M10		0,2 0,4		0,9 1,3
	SH 16x130/200	M10		0,2 0,4		0,9 1,3
	SH 20x85	M12		0,2 0,4		1,6 2,4
	SH 20x85	M16		0,1 0,2		1,7 2,6
4	SH 12x80	M8		0,6 1,2		0,9 1,3
	SH 16x85	M10		0,7 1,4		1,3 1,9
	SH 16x130	M10		1,7 3,4		2,0 3,0
	SH 16x130/200	M10		1,7 3,4		2,0 3,0
	SH 20x85	M12		1,5 2,9		1,3 2,0
	SH 20x85	M16		1,6 3,3		0,6 0,9
5	SH 12x80	M8		0,2 0,3		0,3 0,4
	SH 16x85	M10		0,2 0,4		0,1 0,1
	SH 16x130	M10		0,5 1,0		0,6 0,9
	SH 16x130/200	M10		0,5 1,0		0,6 0,9
	SH 20x85	M12		0,5 0,9		0,1 0,2
	SH 20x85	M16		0,3 0,5		0,2 0,3

Table 10: β -factors for job side tests according to ETAG 029, Annex B

Brick-No.	Installation & use	β -factor
1	w/w (incl. w/d)	0,72
2		
3		
4		
5		

Injection system ECO-FIRST POLYVALENT for masonry

Displacement under shear and tension load
 β -factors for job side tests

Annex 10

of European
 Technical Approval
 ETA-13/0325

Table 11: Edge and axial distances

Without sleeve												
Brick No.	M8		M10		M12		M16					
	C_{min} C_{cr} [mm]	S_{min} S_{cr} [mm]	C_{min} C_{cr} [mm]	S_{min} S_{cr} [mm]	C_{min} C_{cr} [mm]	S_{min} S_{cr} [mm]	C_{min} C_{cr} [mm]	S_{min} S_{cr} [mm]	C_{min} C_{cr} [mm]	S_{min} S_{cr} [mm]		
1	120	240	135	270	150	300	150	300				
2	120	240	135	270	150	300	150	300				
With sleeve												
Sleeve	M8		M10				M12		M16			
	SH12x80		SH16x85		SH16x130		SH16x130/200		SH20x85		SH20x85	
Brick No.	C_{min} C_{cr} [mm]	S_{min} S_{cr} [mm]	C_{min} C_{cr} [mm]	S_{min} S_{cr} [mm]	C_{min} C_{cr} [mm]	S_{min} S_{cr} [mm]	C_{min} C_{cr} [mm]	S_{min} S_{cr} [mm]	C_{min} C_{cr} [mm]	S_{min} S_{cr} [mm]	C_{min} C_{cr} [mm]	S_{min} S_{cr} [mm]
1	120	240	128	255	195	390	195	390	-	-	-	-
2	120	240	128	255	195	390	195	390	-	-	-	-
3	100	497	100	497	100	497	100	497	120	497	120	497
4	100	240	100	240	100	240	100	240	120	240	120	240
5	100	500	100	500	100	500	100	500	120	500	120	500

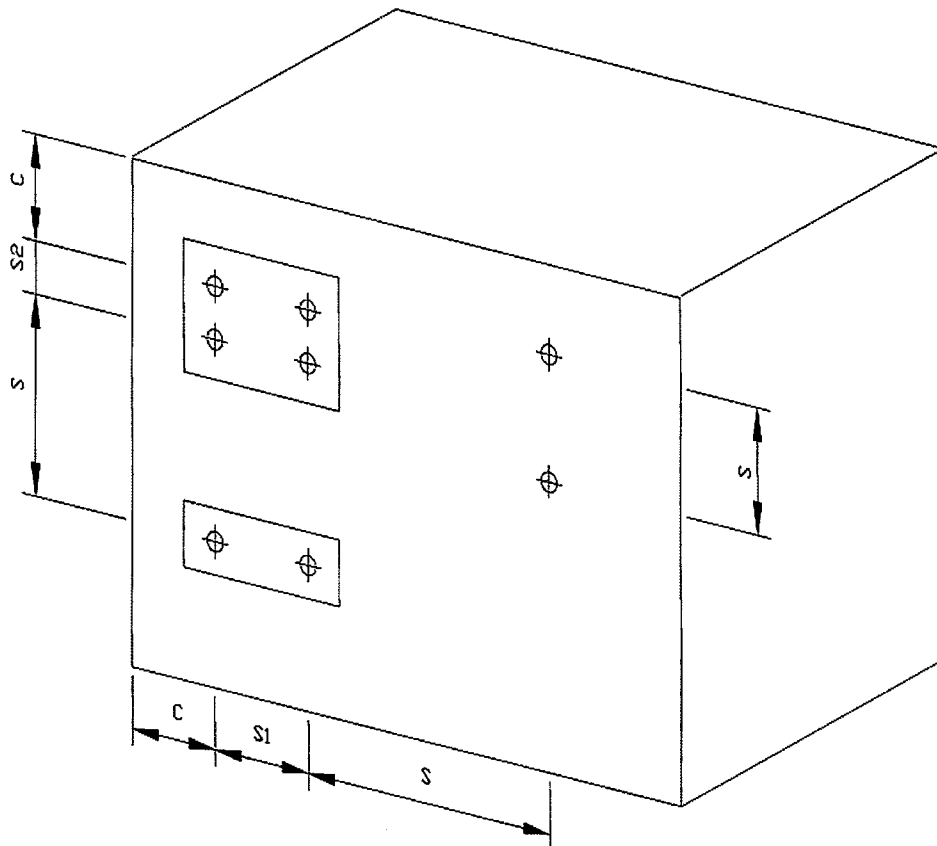

Injection system ECO-FIRST POLYVALENT for masonry

Edge and axial distances

Annex 11
 of European
 Technical Approval
 ETA-13/0325